

OWNER'S MANUAL

Lay-Z-Spa™

220-240V~50Hz, 2050W

Hmax 1.0m Hmin 0.19m IPX5



W[®]
Bestway



Inflate Your Fun™

OWNER'S MANUAL

Lay-Z-Spa™

220-240V~50Hz, 2050W

Hmax 1.0m Hmin 0.19m IPX5

Contents

1. Safety Instructions	P2-3
2. Specifications	P3
3. Installation Instructions	P3-7
Selected Location	
RCD Test	
PRCD Test	
Assembly for Round Pool	
Assembly for Oval Pool	
4. Pump Operation	P8-9
Bleeding the Air Purge Valve	
Control Panel	
Error Messages	
5. Maintenance	P9-10
Filter Cartridge Cleaning & Replacement	
Maintaining Spa Water	
Draining the Spa	
Cleaning the Spa	
Spa Repair	
Lay-Z-Spa Storage	
6. Troubleshooting	P11
7. Disposal	P11
8. Warranty	P12

SAFETY INSTRUCTIONS

WARNING

When installing and using this electrical equipment, basic safety precaution should always be followed, including the following:

IMPORTANT SAFETY INSTRUCTIONS READ AND FOLLOW ALL INSTRUCTIONS.

WARNING: RISK OF ELECTRIC SHOCK. Insert the plug only into a properly grounded socket.

WARNING: The spa must be supplied by an isolating transformer or supplied through a residual current device (RCD) having a rated residual operating current not exceeding 30mA.

WARNING: RCD/PRCD must be tested before each use.

WARNING: If the supply cord is damaged, it must be replaced by the manufacturer, its service agent or similarly qualified persons in order to avoid a hazard.

WARNING: To reduce the risk of electric shock, do not use extension cord to connect unit to electric supply; provide a properly located outlet.

WARNING: No part of the appliance is to be located above the bath during use.

WARNING: Parts containing live parts, except parts supplied with safety extra-low voltage not exceeding 12V, must be inaccessible to a person in spa pool; Earthed appliance must be connected to the fixed socket which is permanently connected to fixed wiring. Parts incorporating electrical components, except remote control devices, must be located or fixed so that they cannot fall into the spa pool.

WARNING: The plug of spa shall be more than 3.5m away from the pool.

WARNING: It is necessary to have the plug accessible after installation of the pool.

WARNING: TO AVOID ELECTRIC SHOCK, DO NOT USE THE SPA WHEN IT IS RAINING.

WARNING: This appliance is not intended for use by persons (including children) with reduced physical, sensory or mental capabilities, or lack of experience and knowledge, unless they have been given supervision or instruction concerning use of the appliance by a person responsible for their safety. Children should be supervised to ensure that they do not play with the appliance.

WARNING: To reduce the risk of injury, do not permit children to use this product unless they are closely supervised at all times.

WARNING: Water attracts children; Always attach a spa cover after each use.

WARNING: Do not bury cord. Locate cord to minimize abuse from lawn mowers, hedge trimmers, and other equipment.

WARNING: To reduce the risk of injury, replace damaged cord immediately.

DANGER: Risk of Accidental Drowning. Extreme caution must be exercised to prevent unauthorized access by children. To avoid accidents, ensure that children can not use this spa unless they are supervised at all times.

WARNING: RISK OF INJURY. Never operate spa if the suction fittings are broken or missing. Never replace a suction fitting.

WARNING: RISK OF ELECTRIC SHOCK. Install at least 1.5m from all metal surface.

WARNING: RISK OF ELECTRIC SHOCK. Never operate any electrical appliance when in your spa or when your body is wet. Never place any electric appliance, such as a light, telephone, radio, or television, within 1.5m of spa.

CAUTION: In order to avoid a hazard due to inadvertent resetting of the thermal cut-out, this appliance must not be supplied through an external switching device, such as a timer, or connected to a circuit that is regularly switched on and off by the utility.

WARNING: During pregnancy, soaking in hot water may cause damage to the fetus. Limit use to 10 minutes at a time.

WARNING: TO REDUCE THE RISK OF INJURY:

A. The water in a spa should never exceed 40°C (104°F). Water temperature between 38°C(100°F) and 40°C(104°F) is considered safe for a healthy adult. Lower water temperatures are recommended for young children and when spa use exceeds 10 minutes.

B. Since excessive water temperatures have a high potential for causing fetal damage during the early months of pregnancy, pregnant or possibly pregnant women should limit spa water temperature to 38°C (100°F).

C. Before entering a spa, the user should measure the water temperature with an accurate thermometer since the tolerance of water temperature regulating device varies.

D. The use of alcohol, drugs, or medication before or during spa use may lead to unconsciousness with the possibility of drowning.

E. Obese persons and persons with a history of heart disease, low or high blood pressure, circulatory system problems, or diabetes should consult a physician before using a spa.

F. Persons using medication should consult a physician before using a spa since some medication may induce drowsiness while other medication may affect heart rate, blood pressure, and circulation.

WARNING: TO REDUCE THE RISK OF INJURY: Never pour water with a temperature higher than 40°C (104°F) into the spa pool directly.

WARNING: The use of alcohol, drugs, or medication can greatly increase the risk of fatal hyperthermia. Hyperthermia occurs when the internal temperature of the body reaches a level that is several degrees above the normal body temperature of 37°C(98.6°F). The symptoms of hyperthermia include an increase in the internal temperature of the body, dizziness, lethargy, drowsiness, and fainting. The effects of hyperthermia include failure to perceive heat; failure to recognize the need to exit spa or hot tub; unawareness of impending hazard; fetal damage in pregnant women; physical inability to exit the spa or hot tub; and unconsciousness resulting in the danger of drowning.

CONSULT YOUR PHYSICIAN FOR RECOMMENDATIONS.

CAUTION: The spa should not be setup or left out in temperature lower than 4°C (40°F).

CAUTION: Do not use the spa alone.

CAUTION: People with infectious diseases should not use a spa.

CAUTION: Do not use the spa immediately following strenuous exercise.

CAUTION: Always enter and exit the spa slowly and cautiously. Wet surfaces are slippery.

CAUTION: To avoid damage to the pump, the spa must never be operated unless the spa is filled with water.

CAUTION: Immediately leave spa if the user feels uncomfortable or sleepy.

CAUTION: Never add water to chemicals. Always add chemicals to water to avoid strong fumes or violent reactions that may result in hazardous chemical spray.

NOTE: Please examine equipment before use. Notify Bestway at the customer service address listed on this manual for any damaged or missing parts at the time of purchase. Verify that the equipment components represent the models that you had intended to purchase.

SAVE THESE INSTRUCTIONS SPECIFICATIONS (FOR #54075)

Capacity:	4 Adults	Heat Element:	Stainless steel, 2,000W
Water Capacity(80%):	900L (240gal)	Pump:	50W Circulation Filter Pump
Inflated Size:	206cmx71cm (81"x28")	RCD Protection:	Yes
Filled Weight:	1,200Kg (2,643Lb)	Power Cable:	4.5m
Power Rate:	220-240V AC, 2050W	Increased Heat Rate:	Approximately 1.5-2°C/h (3-4°F/h)
Temperature Capacities:	40°C (104°F).	Nominal Water Flow:	2,006 L/h (530 gal./h)
Massaging Turbo Blower:	600W	Actual Water Flow:	> 757 L/h (> 200 gal./h)

SPECIFICATIONS (FOR #54090)

Capacity:	4-6 Adults	Heat Element:	Stainless steel, 2,000W
Water Capacity(80%):	1200L (317gal)	Pump:	50W Circulation Filter Pump
Inflated Size:	286cmx183cmx76cm (112.5"x72"x30")	RCD Protection:	Yes
Filled Weight:	1,550Kg (3,414Lb)	Power Cable:	4.5m
Power Rate:	220-240V AC, 2050W	Increased Heat Rate:	Approximately 1°C/h (1.8°F/h)
Temperature Capacities:	40°C (104°F).	Nominal Water Flow:	2,006 L/h (530 gal./h)
Massaging Turbo Blower:	600W	Actual Water Flow:	> 757 L/h (> 200 gal./h)

INSTALLATION INSTRUCTIONS

NOTE: Check to ensure all parts are present.

I: Top Leatheroid Cover

II: Chemical Floater

III: Inflation Hose

IV: Side Tables (for Oval Pool #54090)

V: Pump

VI: Spa with Leatheroid Cover

VII: Repair Patch

VIII: Spa Components

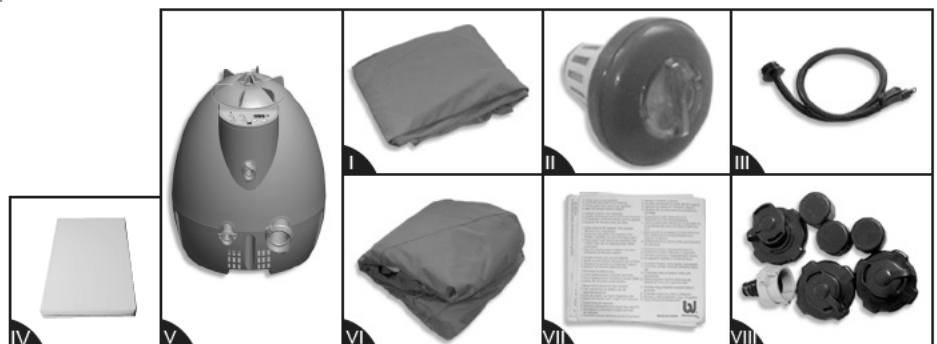

Selected Location

WARNING: The selected location has to be capable of supporting the expected load.

WARNING: An adequate drainage system has to be provided to deal with overflow water.

IMPORTANT: Because of the combined weight of the Lay-Z-Spa, water, and users, it is extremely important that the base where the Lay-Z-Spa is installed is smooth, flat, level and capable of uniformly supporting this weight for the entire time the Lay-Z-Spa is installed. If the Lay-Z-Spa is placed on a surface, which does not meet these requirements, any damage caused by improper support is not covered under the manufacturer's warranty. It is the responsibility of the Lay-Z-Spa owner to assure the integrity of the site at all times.

1. Indoors Installation: Be aware of special requirements if you install the spa indoors.

- The floor must be able to withstand the capacity of the Lay-Z-Spa. The floor should be a non-slip, level surface.
- Proper drainage is essential for indoor spa installation. When building a new room for the spa it is recommended that a floor drain be installed.
- Humidity is a natural side effect with Lay-Z-Spa installation. Determine the effects of airborne moisture on exposed wood, paper, etc. in the proposed location. To minimize these effects it is best to provide plenty of ventilation to the selected area. An architect can help determine if more ventilation is needed.

NOTE: Do not install the Lay-Z-Spa on carpet or other material that can be damaged by moisture.

2. Outdoor Installation

- No matter where you install the Lay-Z-Spa, it is important you have a solid support foundation. If you are installing the Lay-Z-Spa in an outdoor area, ensure there are no sharp objects that could damage it and that the location is level so the Lay-Z-Spa sits properly.
- During filling, draining or when in use, water may spill out of the spa. Therefore the Lay-Z-Spa should be installed near a floor drain.
- Do not leave the spa's surface exposed to direct sunlight for long periods of time.

WARNING: TO AVOID ELECTRIC SHOCK, DO NOT USE THE SPA WHEN IT IS RAINING.

Connect the pump to a residential power supply following the provided two methods:

RCD Test

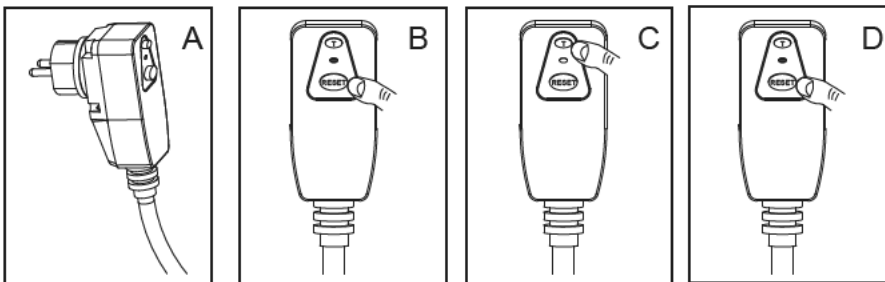

- Insert the plug into the power outlet.
- Press the "RESET" button, the indicator light turns red.
- Press the "TEST" button, the indicator light turns off.
- Press the "RESET" button, the indicator light turns red, the pump is ready for use.

WARNING: RISK OF ELECTRIC SHOCK. The RCD plug must be tested before each use.

WARNING: Insert the RCD plug into a residual current device (RCD) protected power outlet only.

WARNING: Before inserting the plug into a power outlet, make sure the current rate of the power outlet and the fixed wiring are suitable for the pump. Contact a qualified electrician if you cannot verify.

WARNING: Do not use if the above test fails.

PRCD Test

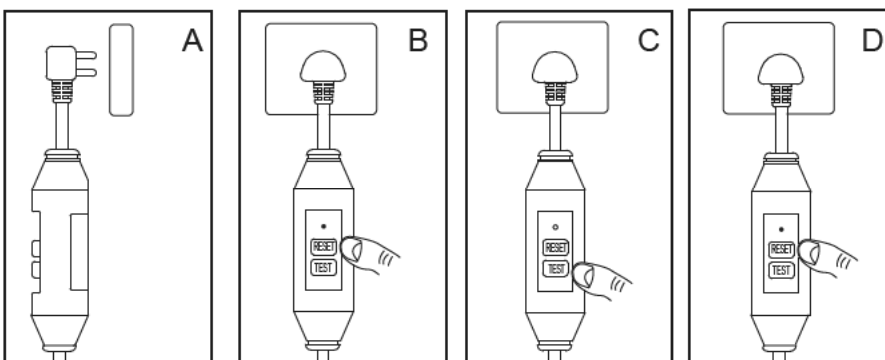

- Insert the plug into a grounded socket.
- Press the "RESET" button, The indicator light turns red.
- Press the "TEST" button, The indicator light turns off.
- Press the "RESET" button, the indicator light turns red. The pump is ready to use.

WARNING: RISK OF ELECTRIC SHOCK. The PRCD plug must be tested before each use.

WARNING: Insert the plug into a residual current device (RCD) protected power outlet only.

WARNING: Before inserting plug into a power outlet, make sure the current rate of the power outlet and the fixed wiring are suitable for the pump.

WARNING: Do not use the pump if this test fails.

Assembly for Round Pool(#54075)

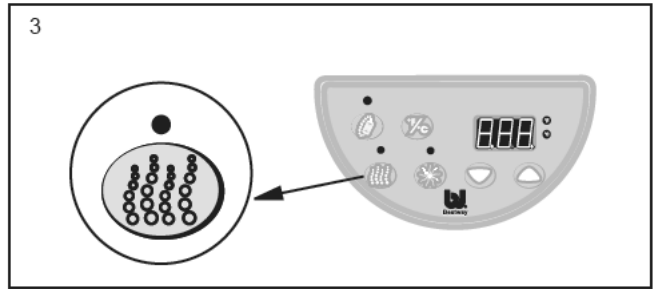
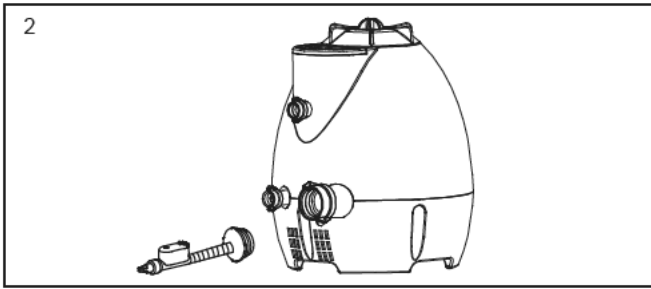

1. Spread out the spa and leatheroid cover and make sure both are right side up.
2. Connect the inflation hose to adapter A on the pump.
3. As previously outlined, test the pump's RCD/PRCD plug and press the Lay-Z-Massage button to activate the pump.

Using the SID-Valve

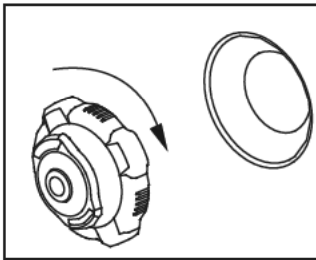

Screw the SID-Valve onto the air intake valve.

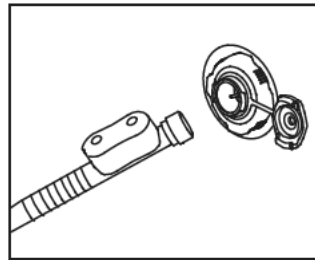

Open the top cover of the SID-Valve, insert the inflation hose and inflate.

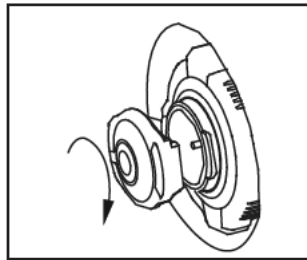

Once inflation is finished, fasten the top cover of the SID-Valve.

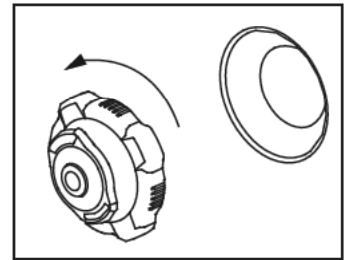

To deflate simply unscrew the SID-Valve counter clockwise from the air intake valve.

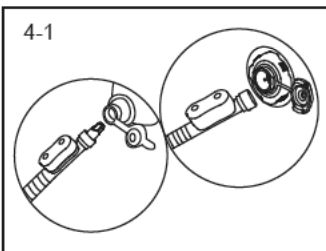

4-1

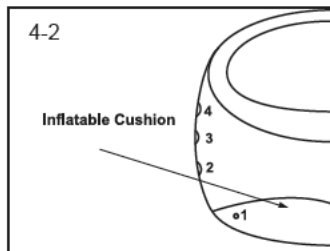

4-2

Inflatable Cushion

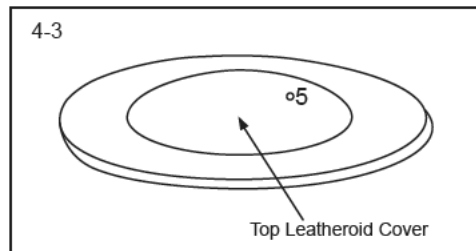

4-3

Top Leatheroid Cover

4. Using the inflation hose, inflate the chambers according to the printed numbers 1, 2, 3, 4, 5.
5. Connect the pump to the spa by lining up the matching letters (A to A, B to B and C to C), and using the adapters to connect the pump to the spa. Ensure the seals are properly in place and hand tighten the adapters securely.
6. Fill the spa using a garden hose. Fill the spa minimum water level to the water level printed on the spa wall.
7. Place the top leatheroid cover over the spa and zip it closed.

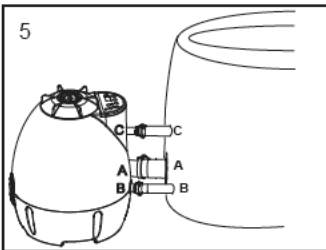

5

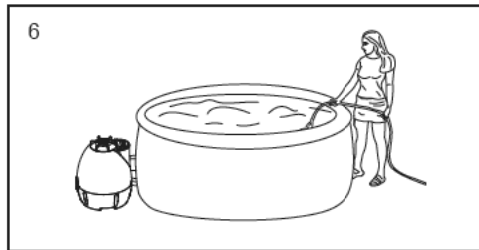

6

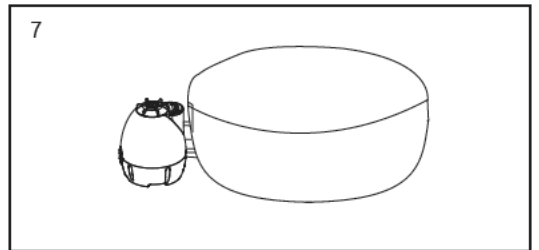

7

WARNING: This spa cover is not a substitute for adult supervision; children must be supervised at all times around the spa.
WARNING: Do not run the Lay-Z-Massage system when the cover is attached, air can accumulate inside the spa and cause irreparable damage and bodily harm.

Assembly for Oval Pool(#54090)



WARNING: TO AVOID THE RISK OF INJURY, DO NOT SIT, CLIMB OR STAND ON THE SIDE TABLE.

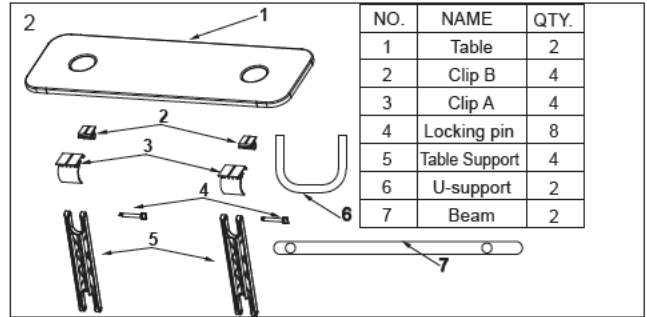

1. Spread out the spa and leatheroid cover and make sure both are right side up.
2. Take a minute to become familiar with the accessories.

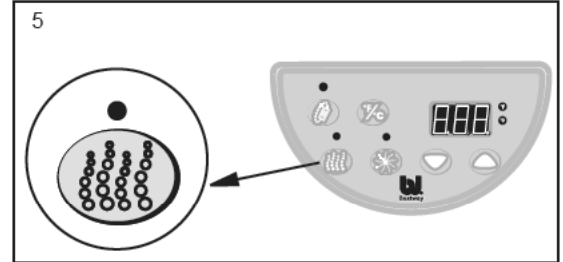
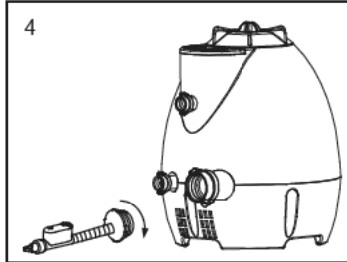
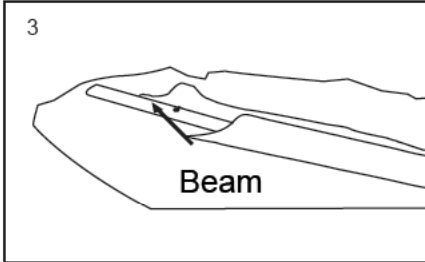

3. Install the side beams by inserting one of the beams into the pole sleeve on the side of the spa. Be sure to line up the holes on the sleeve with the holes on the beam. Repeat this step on the opposite side of the spa.
4. Connect the inflation hose to adapter A on the pump.
5. As previously outlined, test the pump's RCD/PRCD plug and press the Lay-Z-Massage button to activate the pump.

Using the SID-Valve

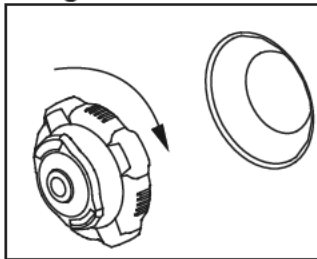

Screw the SID-Valve onto the air intake valve.

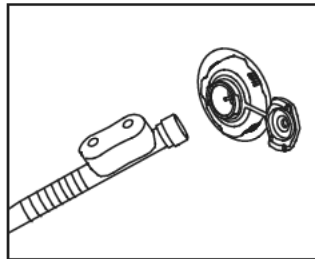

Open the top cover of the SID-Valve, insert the inflation hose and inflate.

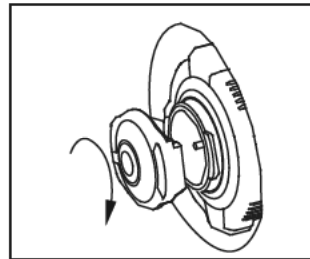

Once inflation is finished, fasten the top cover of the SID-Valve.

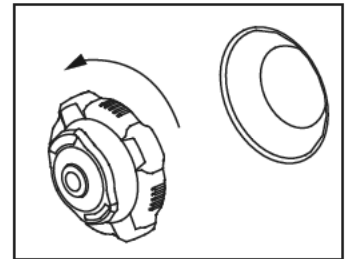

To deflate simply unscrew the SID-Valve counter clockwise from the air intake valve.

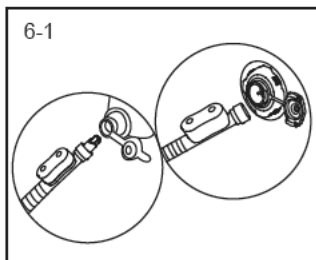

6-1

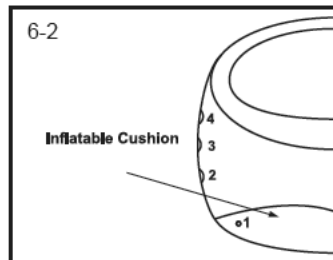

6-2

Inflatable Cushion

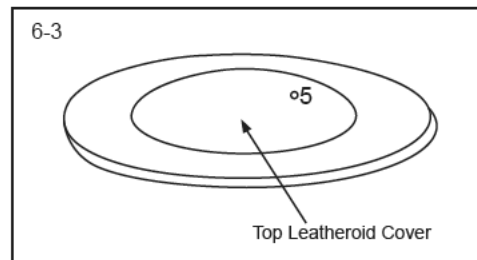

6-3

Top Leatheroid Cover

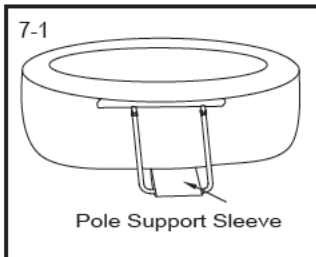

7-1

Pole Support Sleeve

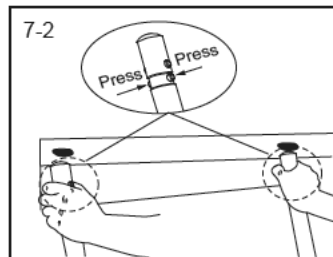

7-2

Press Press

6. Using the inflation hose, inflate the spa chambers according to the printed number 1, 2, 3, 4, 5.
7. Insert the U-Supports through the pool support sleeve at the bottom of the spa, insert the two ends of the U-Supports into the exposed holes on the beam and ensure the spring-loaded pins snap into position. Repeat this step on the opposite side of the spa.

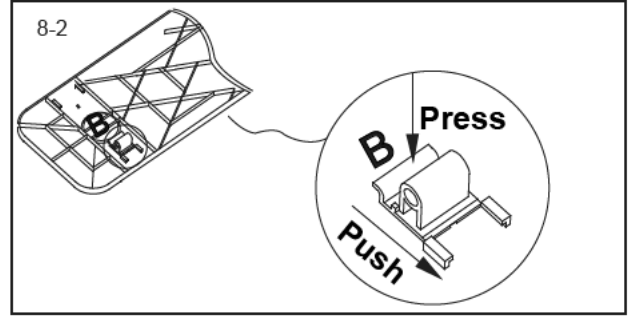
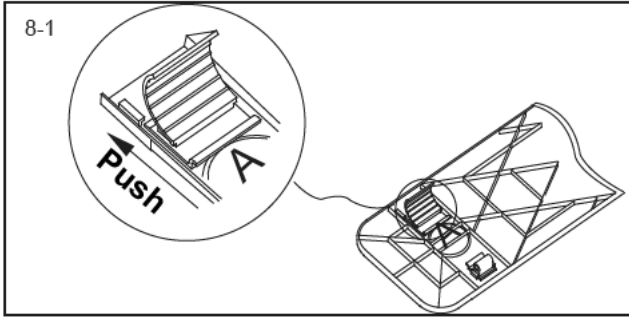

8. Locate the markings A and B on the bottom of the side tables and insert the corresponding clips by pressing down on the tabs and slide the clips into position.

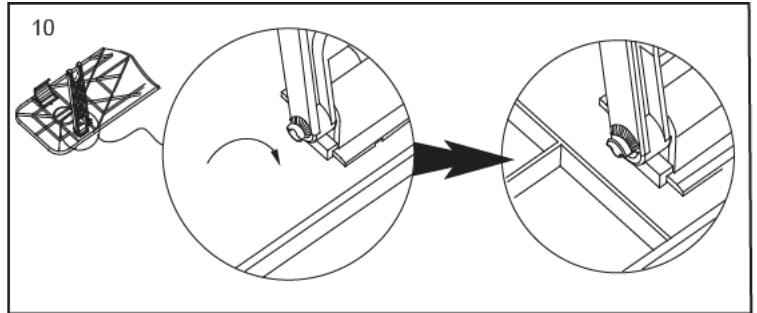
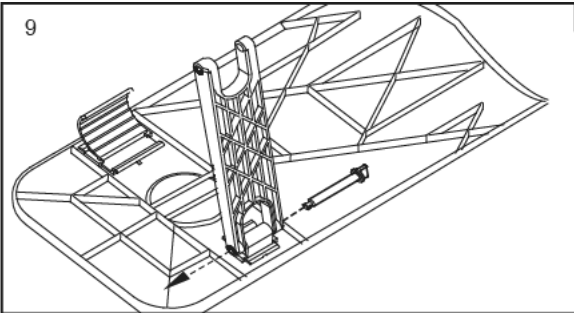

9. Align the table supports with Clips B and insert the locking pin. Repeat this step for the opposite table.
 10. Rotate the locking pin 180° to lock them into position. Repeat this step for the opposite table.
 11. Install the side tables on the beams.

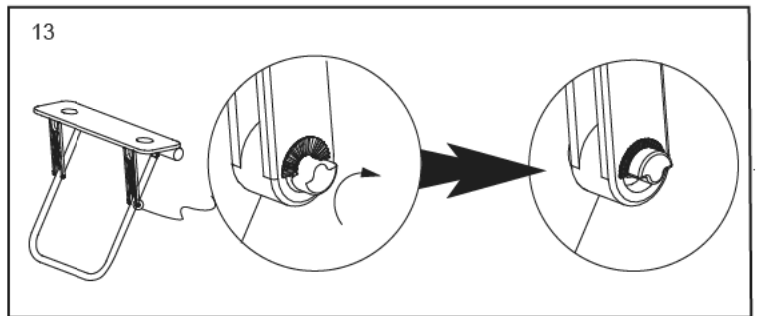
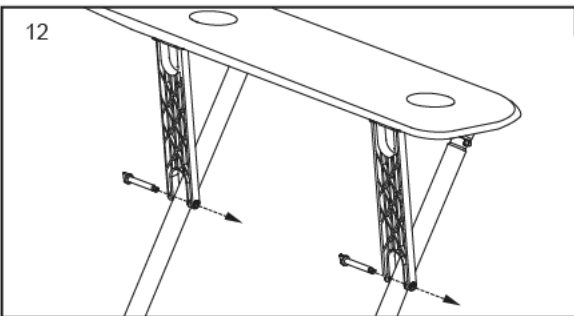

12. Align the holes on the table supports to the holes on the U-Supports and insert the locking pin.
 13. Rotate the two locking pins 180° to lock them into position. Repeat this step for the opposite table.

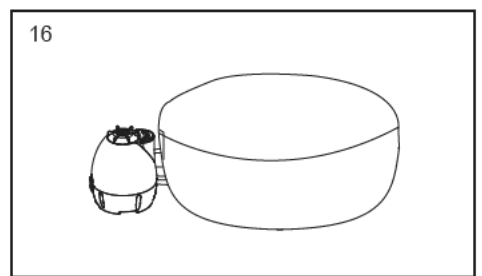
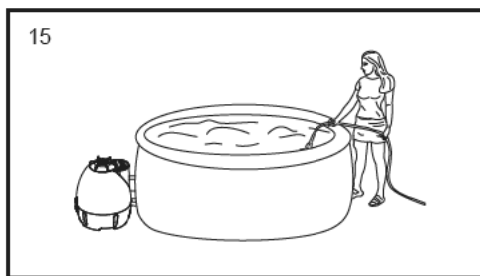
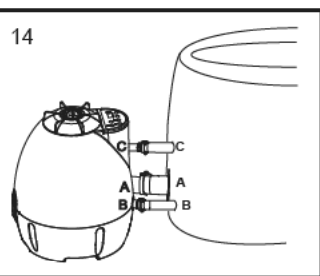

14. Connect the pump to the spa by lining up the matching letters (A to A, B to B and C to C), and using the adapters to connect the pump to the spa. Ensure the seals are properly in place and hand tighten the adapters securely.
 15. Fill the spa using a garden hose. Fill the spa minimum water level to the water level printed on the spa wall.
 16. Place the top leatheroid cover over the spa and zip it closed.

WARNING: This spa cover is not a substitute for adult supervision; child must be supervised at all times around the spa.
WARNING: Do not run the Lay-Z-Massage system when the cover is attached, air can accumulate inside the spa and cause irreparable damage and bodily harm.

PUMP OPERATION

Bleeding The Air Purge Valve

NOTE: Water must be at the printed level on the spa wall.

NOTE: Bleeding the air purge valve is the key step to ensure the pump runs normally.

CAUTION: You must ensure the pump is prepared before operating, if you do not follow these instructions the pump may operate abnormally. Never dry run the pump as this type of damage is not covered by the warranty.

1. Open the air purge valve located on the top of the pump by turning the knob counter clockwise. Maximum ventilation occurs with two full turns of air purge valve.

NOTE: If the valve becomes unthreaded, simply place it back on and turn clockwise to rethread.

2. With the pump running and air purge valve open, water will begin to flow into the pump releasing air from the system. This process will take about 30 seconds depending on the amount of the water in the spa and the pump.
3. When water begins to flow from the opening of the air purge valve, close the valve and dry any excess water from the surface of the pump.

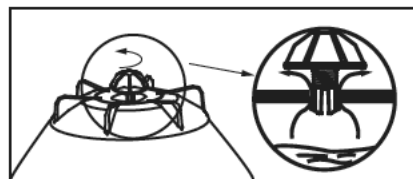

Control Panel

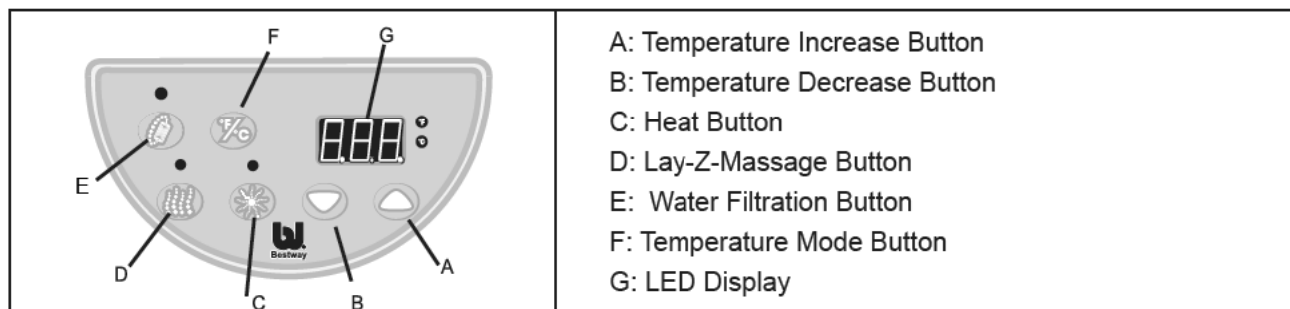

LED Display: Once powered-up the LED displays the current water temperature automatically.



Temperature Mode Button: The temperature can be displayed in either Fahrenheit or Celsius. To toggle between these choices simply press this button.

NOTE: The system's default is Celsius.



Temperature Adjustment Buttons:

Pressing the Temperature Increase or Temperature Decrease buttons will cause the LED to flash. When flashing you can adjust to the desired temperature setting. If you hold these buttons down the values will rapidly increase or decrease. The new and desired temperature setting will remain on the LED display for 5 seconds to confirm the new value.

NOTE: The default temperature is 40°C (104°F) when first plugged in.

NOTE: Temperature adjustment ranges from 20°C (68°F) to 40°C (104°F).

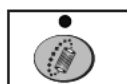

Water Filtration Button: This button turns the filter pump on and off.

The light above the Water Filtration Button displays green when activated.

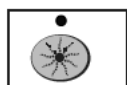

Heat Button: Use this button to activate the heating system, and the Lay-Z-Massage System will shut off automatically.

The pump will heat the spa water until the water temperature reaches 1°C (1.8°F) higher than the input desired temperature. After the current water temperature drops 2°C (3.6°F) below the input desired temperature the heating system will restart.

When the light above the heat button is red, the heating system is activated. When the light is green, the water is at the input desired temperature and the heating system is at rest.

The #54075 rapid heating system is capable of increasing water temperature by approximately 1.5 to 2°C (3-4°F) per hour.

The #54090 rapid heating system is capable of increasing water temperature by approximately 1°C (1.8°F) per hour.

NOTE: If the heating system is activated the filtration system will automatically start.

NOTE: After turning off the heating system the filtration system will continue to operate.

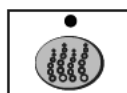

Lay-Z-Massage Button: Use this button to activate the massage system which has a 30-minute auto shut off feature and the heating system will shut off automatically.

The light above the Lay-Z-Massage Button displays green when activated.

WARNING: Do not run the Lay-Z-Massage system when the cover is attached, air can accumulate inside the spa and cause irreparable damage and bodily harm.



After 24 hours of operation, the pump will hibernate. "End" will be displayed on the LED. When the pump is hibernating both the rapid heating and water filtration functions are disabled. To re-activate the pump simply press any buttons on the control panel.

Error Messages

Symptom	Problem Causes	Solutions
The LED displays E00 and all the lights flash	The household power supply is not equipped with a residual current device.	Turn to a qualified electrician.
The LED displays E01 and all the lights flash	System error.	Replug the RCD plug. (If this does not solve the problem, please consult Bestway or your dealer).
The LED displays E02 and all the lights flash	No water flow.	If the adapters of the pump & the spa are blocked or the filter cartridge is too dirty. Replace the filter cartridge if necessary. (If this does not solve the problem, please consult Bestway or your dealer).
The LED displays E03 and all the lights flash	Water temperature too low.	If the environment temperature is below 4°C we recommend not to use the spa or pump.
The LED displays E04 and all the lights flash	Water temperature too high.	Unplug the pump. When the water cools restart (If this does not solve the problem please consult Bestway or your dealer).
The LED displays E05 and all the lights flash	Something is wrong with the pump.	Consult Bestway or your dealer.
The LED displays End	After 24 hours of operation, the pump will hibernate and the rapid heating and water filtration functions are disabled.	To re-activate the pump simply press any button on the control panel.

MAINTENANCE

CAUTION: YOU MUST ENSURE THE PUMP IS UNPLUGGED BEFORE BEGINNING SPA MAINTENANCE OR SEVERE RISK OF INJURY OR DEATH EXISTS.

Filter Cartridge Cleaning / Replacement

NOTE: To ensure water stays clean, please clean the filter cartridge every day and change the filter cartridges every two weeks.

1. Unplug the pump.
2. To prevent water from escaping when cleaning or replacing the filter cartridge, reach inside the spa and insert the three stopper caps onto the spa's inside adapter and skimmers.
3. Remove the top of the pump by unscrewing the cap retainer.
4. Remove the cap.
5. Remove the filter cartridge by lifting it straight out of the pump housing.
6. The filter cartridge can be rinsed off with a garden hose and reused. However, if the filter cartridge remains soiled and discolored the filter cartridge should be replaced. It is recommended to replace filter cartridges every two weeks.
7. Insert the cleaned filter cartridge into the center of the pump's housing.
8. Check to make sure the pump cap seal is placed correctly on the top rim of the housing.
9. Replace the pump cap back into position.
10. Replace the pump cap retainer and lock it into position by turning it clockwise.
11. Reach inside the spa and remove the three stopper caps from the spa's adapter and skimmers. This will allow water to flow into the pump.
12. Using the previously outlined steps, test the RCD/PRCD plug, bleed the air purge valve, and restart the pump.

NO.	NAME	NO.	NAME
P4014Q09-01-01	Air Purge Valve	58094	Filter Cartridge
P4014-01-02	Air Purge Valve Seal	P4014-04-19	Adapter A Seal
P4014Q09-01-03	Pump Cap Retainer	P4014-01-27	Adapter C Seal
P4014Q09-01-04	Pump Cap	P4014-01-27	Adapter B Seal
P4014-01-05	Pump Cap Seal		

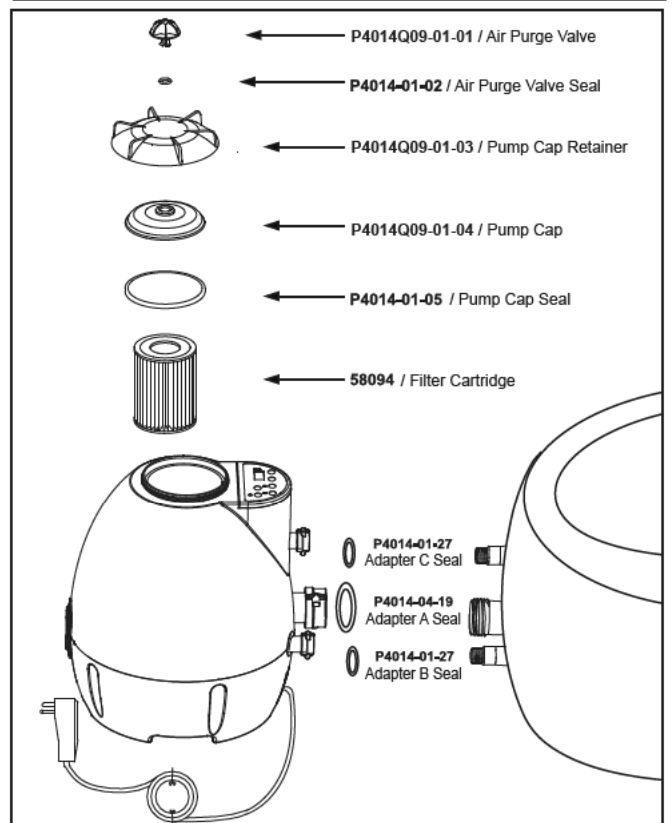

Maintaining Spa Water

Poor water quality can be extremely hazardous to your health. We recommend you do the following things:

A: Clean filter every day and change filter every two weeks depending on use.

B: Change water every few days or use appropriate spa pool chemicals.

All spas require the use of pool chemicals. Please consult your local pool supply retailer for more information about chemical maintenance. Pay close attention to the chemical manufacturer's instructions. Spa damage resulting from misuse of chemicals and mismanagement of spa water is not covered by the warranty.

1. Water Balance

We recommend to maintain your water pH between 7.2 and 7.8, total alkalinity between 80 and 120ppm and free chlorine between 3 to 5ppm. Purchase a test kit to test your water chemistry before each using of the spa, no less than once per week. Low pH will damage to the spa and pump. Damage resulting from chemical imbalance is not covered by the warranty.

2. Water Sanitation

Water Sanitation is the responsibility of the spa owner, and should be maintained through the regular and periodic (daily, if necessary) addition of approved sanitizer. The sanitizer will chemically control the bacteria and viruses present in the spa water that are caused during use of the spa.

Draining the Spa

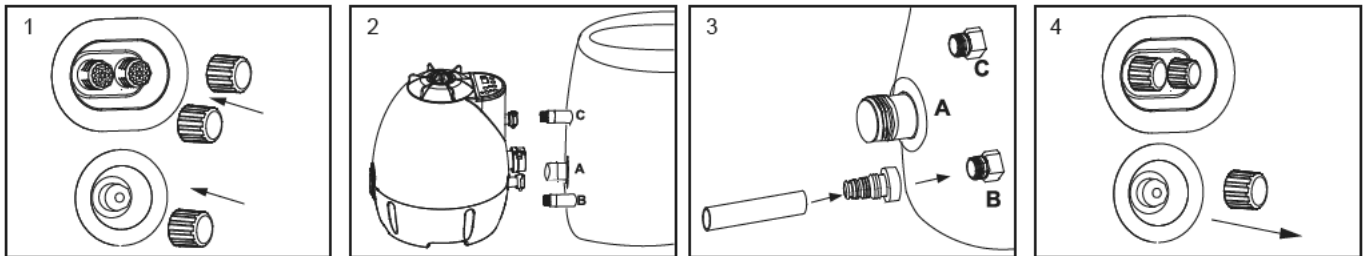

1. In order to prevent water from escaping, insert the three stopper caps onto the spa's inside adapter and skimmers.

2. Disconnect the pump from the spa.

3. Connect the hose adapter to your garden hose and attach the hose adapter to the spa's B adapter.

4. With your hose positioned in a selected drain area, remove the lower stopper cap from inside the spa to release the water. Once the spa water has been drained below the spa's bottom air chamber, unscrew the SID- Valve counter clockwise from it's base to deflate the chamber, doing this will allow the spa water to be drained thoroughly.

Cleaning the spa

Detergent residues and dissolved solids from bathing suits and chemicals will gradually accumulate in the spa's water.

To clean the spa, use soap and water then rinse.

NOTE: DO NOT use hard brushes or abrasive cleaners.

Spa Repair

If the Spa is torn or punctured, use the provided Repair Patch.

1. Dry the area to be repaired.

2. Remove the patch backing and place the patch over the damaged area.

3. Smooth the surface to remove any air bubbles. A secure unnoticeable repair can usually be made.

Lay-Z-Spa Storage

Make sure all water is drained from the spa and pump. This is essential to extend the life of the spa. We recommend the use of a wet/dry vacuum to blow out or suck up water from the spa pipes and pump lines. Remove the filter cartridge. It is recommended you store the spa in its original package in a warm dry place.

NOTE: Plastic becomes brittle and susceptible to breaking when exposed to subzero temperatures. Freezing can severely damage the spa. Improper winterization of your spa can void your warranty.

TROUBLESHOOTING

Bestway strives to provide the most trouble-free Spas on the market. If you experience any problems whatsoever, do not hesitate to contact Bestway or your authorized dealer.

Here are some helpful tips to help you to diagnose and rectify some common sources of trouble.

Problems	Probable Causes	Solutions
Pump does not operate	-Power failure -RCD/PRCD tripped -RCD/PRCD broken	-Check power source -Reset RCD/PRCD and check if the home fixed wiring is too thin to handle 2050W. -Call for service if it does not reset
Pump not heating properly	-Temperature set too low -Dirty Filter Cartridge -Improper water levels -Forget to remove the 3 Stopper Caps -Heating element failed	-Set to a higher temperature -Clean/replace the Filter Cartridge in time -Add water to specified levels -Remember to remove the 3 Stopper Caps before heating -Call for service
Lay-Z-Massage System does not work	-Pump is too hot -30-minute auto shut off feature activated -Something is wrong with the Pump	-Unplug the Pump. After the Pump has cooled insert the plug and press the Lay-Z-Massage Button to activate -Press the Lay-Z-Massage Button to reactivate -Call for service if it does not reset
Water Filtration not working	-Did not bleed the air purge valve before operating the pump -Dirty Filter Cartridge	-Bleed the air purge valve -Clean/replace the Filter Cartridge in time
Adapter leakage	-Adapter Seal not in right position	-Replace the seal and check
Pump adapters are not level with the spa adapters	-One characteristic of PVC is that it changes shape, which is normal	-Elevate the pump with wood or another type of insulated material to bring the pump's adapters level with the spa's adapters.
Spa leakage	-Spa is torn or punctured	-Use provided Repair Patch
Water not clean	-Insufficient filtering time -Dirty Filter Cartridge -Improper water maintenance	-Increase filtration time -Clean/replace the Filter Cartridge -Refer to the chemical manufacturer's instructions

DISPOSAL



Meaning of crossed-out wheeled dustbin:

Do not dispose of electrical appliances as unsorted municipal waste, use separate collection facilities.

Contact your local government for information regarding the collection systems available.

If electrical appliances are disposed of in landfills or dumps, hazardous substances can leak into the groundwater and get into the food chain, damaging your health and well-being.

When replacing old appliances with new ones, the retailer is legally obligated to take back your old appliance for disposals at least free of charge.

Limited BESTWAY® Manufacturer's Warranty

The product you have purchased comes accompanied with a limited warranty. At Bestway® we stand behind our quality guarantee and assure, through a replacement warranty, your product will be free from manufacturer's defects resulting in leaks.

To enact a claim simply filled out this warranty card and returned it to us with:

For Spa:

- 1) Your purchase receipt
- 2) Problem with the Spa, cut and copy the batch number (2086-xxxxxx) located near the air valve on the Inflatable Cushion to your receipt.

For Pump:

- 1) Your purchase receipt
- 2) Pump to be sent by post to the address of the after-sales center contacted, for details please refer to your country according to the information you find on the back cover.

Bestway is not responsible for economic loss due to water or chemical costs. Bestway will not replace any products deemed to have been neglected or having been used outside of the owner manual guidelines.

TO: Bestway Service Department

DATE _____

Customer Code Number _____

FAX/E-MAIL/TEL: Please refer to your country according to the information you find on the back cover

Required Information:

Name: _____ Address: _____

Zip code: _____ City: _____

Country: _____ Telephone: _____

Mobile: _____ E-mail: _____

Fax: _____

Please Clearly Write Your Item Code:

Item code: _____

Description of Problem

- Spa leaking RCD/PRCD/GFCI tripped
 Control panel shows the failure which can not be solved Water Filtration System not working
 Lay-Z-Massage System not working Heating System not working
 Pump leaking Adapter leaking
 Missing Parts - Please use the code for the missing part, this can be found in the owner's manual.

Other (please describe): _____

For request of spare parts consumer has to send us also the page of the manual with a cross near the missing or faulty part.

You also have to send a copy of your purchase receipt together with this fax

The free-toll number can not be reachable by the mobile phones.

In order to best assist you, we request all information you provide is complete.

YOU CAN ALSO VISIT OUR WEB SITE: www.bestway-service.com